

# Electric Supercharging Technology for Automobiles



NAOMICHI SHIBATA\*<sup>1</sup>    BYEONGIL AN\*<sup>2</sup>  
 YASUAKI JINNAI\*<sup>3</sup>    MOTOKI EBISU\*<sup>4</sup>  
 YUKIO YAMASHITA\*<sup>5</sup>

*In the automobile environmental regulations of each country, significant fuel consumption reduction and cleaner exhaust gas are required under conditions closer to real driving. To satisfy environmental regulations, which are becoming increasingly strict every year, powertrain electrification has been advancing lately. Various types of electric motor vehicles including hybrid vehicles, plug-in hybrid vehicles, 48V mild hybrid vehicles (MHEV) with engines, electric vehicles (EV), and fuel cell vehicles (FCV) without engines are currently on the market. Mitsubishi Heavy Industries Engine & Turbocharger Co., Ltd. (MHIET) has contributed to fuel consumption reduction and cleaner exhaust gas through turbochargers. Utilizing these results, we have developed electric supercharging technology applicable to future powertrains and proposed it to automobile manufacturers. In this paper, MHIET presents this electric supercharging-related technology.*

## 1. Introduction

To satisfy environmental regulations for automobiles, vehicle electrification is required. Among these efforts, European automobile manufacturers are advancing the market introduction of 48V MHEV featuring high-efficiency technology of the vehicle auxiliary equipment by raising the rated voltage from the conventional 12V to 48V. MHIET is developing a two-stage electric turbocharger system with an electric supercharger and an electrically-assisted turbocharger as an electric supercharging system applicable to 48V MHEV, and has proposed them to automobile manufacturers as effective technologies for improving powertrain efficiency and for cleaner exhaust gas.

From the next section, other electric supercharging-related technologies are explained focusing on evaluation cases of engines equipped with 48V electric superchargers.

## 2. 48V Electric supercharger

**Table 1** shows the specifications of the 48V electric supercharger developed by MHIET. The electric supercharger realized compactness and light weight by installing a motor coaxially with a centrifugal compressor and integrating the motor and power electronics. The electric supercharger is electrically connected to the vehicle ECU\*<sup>1</sup> by CAN\*<sup>2</sup> communication. The power performance and environmental performance of the powertrain are improved by controlling the boost pressure at fast response. The maximum motor output is 5 kW, and the response time from stop to 90% of the maximum rotational speed is 0.3 seconds or less, and the continuous operation time is 30 seconds.

Furthermore, continuous operation becomes possible by suppressing the output to 3 kW. To achieve the above performance, the motor, power electronics and bearings are cooled by water. In consideration of the engine room mounting, a grease packed ball bearing without oil lubrication is adopted.

\*1 Engineering Department, Turbocharger Division, Mitsubishi Heavy Industries Engine & Turbocharger Co., Ltd.

\*2 Chief Staff Manager, Engineering Department, Turbocharger Division, Mitsubishi Heavy Industries Engine & Turbocharger Co., Ltd.

\*3 Deputy Director, Engineering Division, Turbocharger Division, Mitsubishi Heavy Industries Engine & Turbocharger Co., Ltd.

\*4 Chief Staff Manager, Engineering Department, Turbocharger Division, Mitsubishi Heavy Industries Engine & Turbocharger Co., Ltd.

\*5 Manager, Electricity & Applied physics Research Department, Research & Department Center, Mitsubishi Heavy Industries, Ltd.

**Table 1 48V Electric supercharger specifications**

Item	Specification	
Input voltage	48V	
Motor type	Flux Switching Motor	
Maximum speed	80,000 rpm	
Maximum pressure ratio	1.7	
Output	Maximum	5 kW (30 s)
	Continuous	3 kW
Response time	< 0.3 s (0 to 90% rpm)	
Cooling method	Water cooling	
Bearing type	Grease packed ball bearing	

A flux switching motor has the advantages of no magnets, low cost and high efficiency. <sup>(1)</sup>

**Figure 1** shows the configuration of the two-stage electric turbocharger. The intake side is made to be a two-stage layout of an electric supercharger and a turbocharger. The electric supercharger can output the boost pressure and the transient response when the engine load is low and the turbocharger rotation speed is low. When the engine load rises, the turbocharger can satisfy the required boost pressure. Then the electric supercharger output is lowered and the bypass valve is opened. The advantages with an electric supercharger are shown below:

- Improvement of engine power performance (Improvement of engine low-speed torque and transient response)
- Supply of boost pressure required for fuel consumption reduction engine technology (Miller cycle <sup>\*3</sup>, EGR <sup>\*4</sup>, etc.), and improvement of fuel consumption by enabling further turbocharging downsizing.

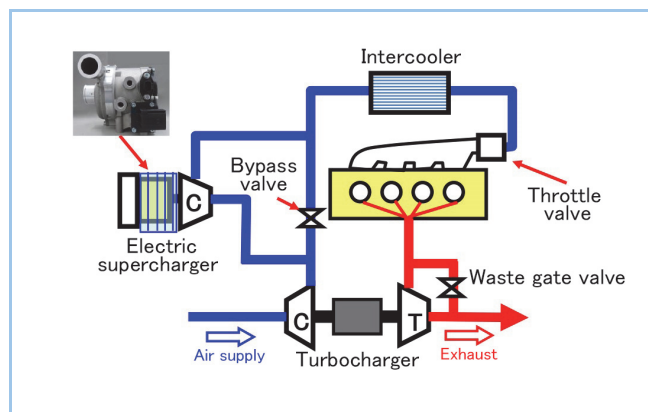
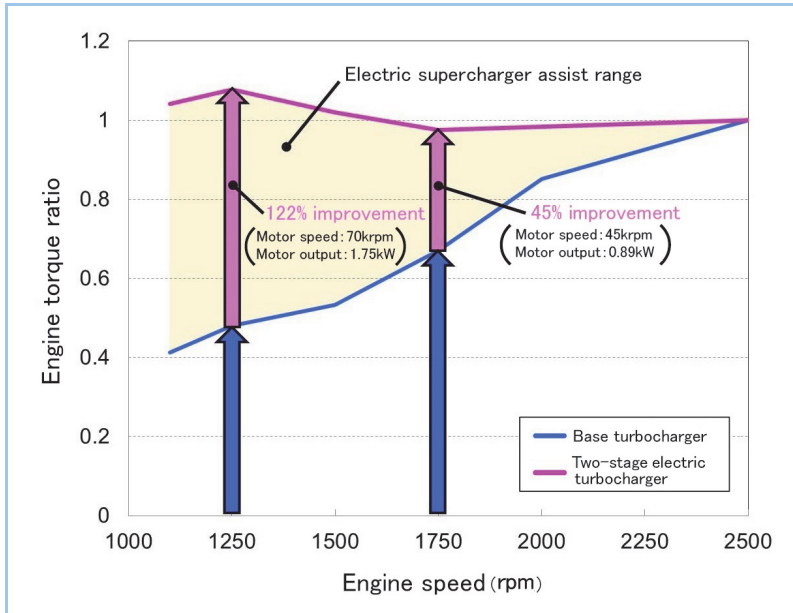

**Figure 1 Structure of two-stage electric turbocharger**

### 3. Evaluation on engine bench

The performance test was carried out on an engine bench to confirm the performance and controllability of the two-stage electric turbocharger. The test engine is a 2.0 L gasoline engine with a maximum torque of 422 Nm and a maximum output of 221 kW.

**Figure 2** shows the steady-state performance of the engine. The two-stage electric turbocharger and the base turbocharger is compared with the torque ratio based on the steady full load torque at the engine revolution speed of 2500 rpm. At the low engine speed of 1250 rpm, the engine torque of the two-stage electric turbocharger is improved by 122% in comparison with the base turbocharger. At the engine speed of 1750 rpm, the engine torque is improved by 45% in comparison with the base turbocharger. Since the exhaust gas energy increases with the engine speed increasing and the turbocharger output improves, the engine full load torque is obtained even if the electric supercharger output is lowered. Further assistance is also possible, because there is a margin in the rotational speed and output of the electric supercharger at each engine rotational speed.



**Figure 2 Engine steady-state performance**

**Figure 3** shows the transient performance at an engine speed of 2000 rpm. The engine torque response when the throttle valve was operated from idling to the full opening was confirmed. Since the intake piping of the two-stage electric turbocharger is longer than that of the base turbocharger, the pressure loss at idling increases and the engine torque slightly decreases. The two-stage electric turbocharger improved the transient response by 80% in comparison with the base turbocharger. Although the electric supercharger could not be driven at the maximum rotational speed and maximum output due to the convenience of the test engine equipment, further assistance is possible and response time improvement is expected.

From the above, it was confirmed that steady-state torque and transient response at low engine speed were significantly improved with the electric supercharger assistance by the two-stage electric turbocharger. It is expected that the drivability of the vehicle will be improved while maintaining the maximum output by enhancing the low-speed performance of the engine.

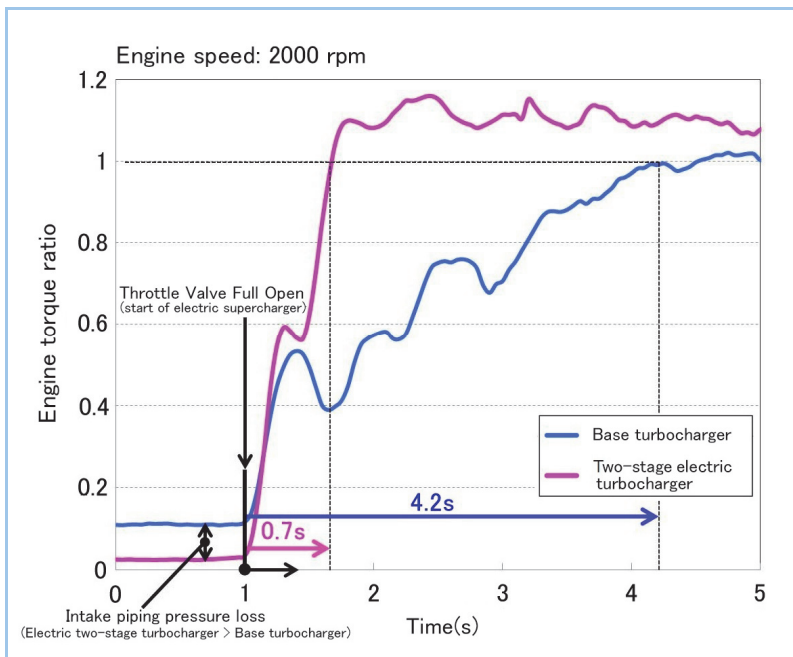

**Figure 3 Engine transient performance**

## 4. Vehicle driving simulation

The vehicle driving analysis was carried out with the 1D engine simulation tool. The effectiveness in the vehicle driving mode of the two-stage electric turbocharger was confirmed. **Table 2** shows the analysis conditions and the driving mode. Using a gasoline 2.0 L vehicle model, a comparison between a two-stage electric turbocharger and a base turbocharger was carried out. WLTC (Worldwide harmonized Light vehicles Test Cycle) mode covering operations from urban district driving to high-speed driving was selected. Then, Miller cycle and EGR were applied for engine fuel consumption reduction technology. Miller cycle is a technology to shorten the compression stroke and substantially increasing the expansion stroke by controlling the engine cylinder intake valve and to improve the engine thermal efficiency. EGR is a technology to reduce the pressure loss in the throttle valve and improve the margin of knocking and the heat loss in engine combustion by recirculating engine exhaust gas to the intake side. These technologies are effective for fuel consumption reduction. However, when these technologies are applied, engine torque decreases because the fresh air intake decreases. In this simulation, the electric supercharger and turbocharger were controlled to compensate for the engine torque reduction. Furthermore, electric power was generated during driving so that the SOC<sup>\*6</sup> of the battery becomes equal before and after the driving mode, and the fuel consumption was evaluated by adding the electric energy consumption of the electric supercharger driving.

**Table 2 Analysis conditions and driving mode of two-stage electric turbocharger**

Items	Analysis Conditions	Driving Mode Diagram
Engine	1. Gasoline 2.0 L turbocharger 2. Gasoline 2.0 L two-stage electric turbocharger (Electric Supercharger + Turbocharger)	
Driving mode	WLTC (Worldwide harmonized Light vehicles Test Cycle)	
Control	<ul style="list-style-type: none"> <li>Fuel consumption reduction engine technology: Miller cycle + EGR</li> <li>Equivalent SOC of battery before and after driving</li> </ul>	

**Figure 4** shows the results of steady-state simulation of the engine with Miller cycle and EGR. The engine speed, engine torque and fuel consumption of the two-stage electric turbocharger and the base turbocharger were compared. In the two-stage electric turbocharger, the engine low-speed and high-torque range applied the Miller cycle and EGR is expanded with the electric supercharger assistance in comparison with the base turbocharger, and the fuel consumption is reduced. Furthermore, the pumping loss<sup>\*7</sup> of the engine is reduced by positively using the electric supercharger in the output range and exhausting without passing through the turbocharger, and the fuel consumption is reduced. Thus, two-stage electric turbocharger application was effective for the expansion of the Miller cycle and EGR application range and pumping loss reduction.

**Figure 5** shows the 1D engine simulation results of the engine output operating point in WLTC mode. In the two-stage electric turbocharger, the integrated fuel consumption including the electric energy balance in electric supercharger driving was reduced by 1.0% compared to the base turbocharger. It is considered that the application of Miller cycle and EGR and the pumping loss reduction of the engine reduce the fuel consumption in the engine operating range. Although the transmission control was calculated as the same, it is considered that further fuel consumption improvement is possible by optimizing the control of the engine speed and engine torque to provide good fuel consumption.

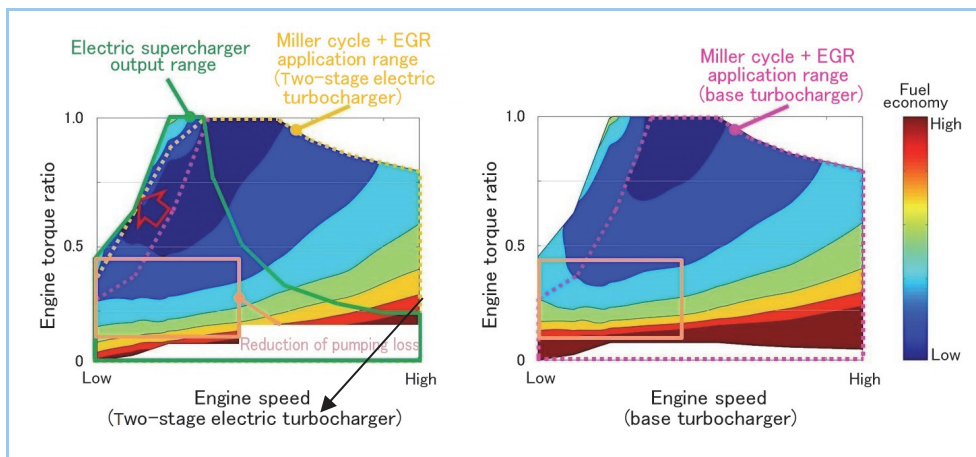

Figure 4 Engine steady-state simulation (Miller cycle + EGR)

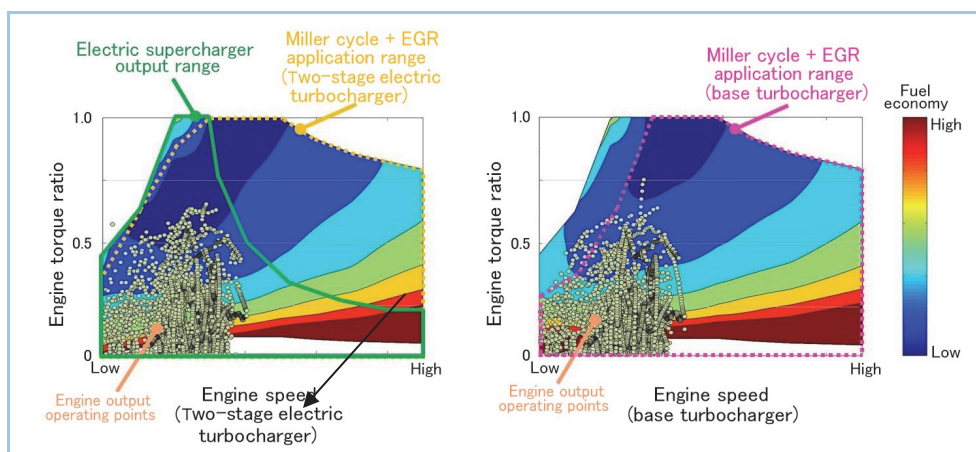





Figure 5 WLTC mode simulation

## 5. Introduction of other technologies related to electric supercharging

Table 3 presents other electric supercharging-related technologies for future powertrains. The following is an outline of each development technology.

Table 3 Powertrains and Electric Supercharging-related Technologies

Powertrain	Electric Supercharging-related Technology	Usage	Overview
48V MHEV	Two-stage electric turbocharger (Electric supercharger + turbocharger)	[Usage] <ul style="list-style-type: none"> <li>Improvement of engine power performance</li> <li>Application of technologies to reduce engine fuel consumption (Miller cycle, EGR, lean burn, etc.)</li> </ul>	
	Electrically-assisted turbocharger	Energy regeneration (Electrically-assisted turbocharger) [Characteristics] <ul style="list-style-type: none"> <li>Fast response</li> <li>Small size, Light weight</li> </ul>	
EV	Micro Gas Turbine for Range Extender	[Usage] <ul style="list-style-type: none"> <li>To extend the cruising range of EV</li> <li>More freedom in charging timing</li> </ul> [Characteristics] <ul style="list-style-type: none"> <li>Capable of adapting to a variety of fuels</li> <li>Small size, Light weight</li> </ul>	
FCV	Electric compressor	[Usage] <ul style="list-style-type: none"> <li>Supply air to the fuel cell stack</li> </ul> [Characteristics] <ul style="list-style-type: none"> <li>Small size, light weight, high efficiency, low noise</li> </ul>	

### 5.1. Electrically-assisted turbocharger

The electrically-assisted turbocharger installed coaxially with the motor and the turbocharger is driven by the electric motor and the exhaust turbine. Since the turbine driving force is assisted by the motor, boost pressure can be improved at low engine load with low exhaust gas energy and transient response. Therefore, the low-speed torque and engine transient response are improved. Since the size is not significantly different from a conventional turbocharger, the engine room mounting is excellent, and it is also possible to regenerate the exhaust gas energy as electric power by utilizing the motor as a generator in the operation range. At low engine speed, the response is improved more than 80% in comparison with a conventional turbocharger. MHIET is developing several kinds of electrically-assisted turbochargers such as a maximum output exceeding 5 kW according to the turbocharger size.

### 5.2 Micro Gas Turbine for Range Extender

MHIET has been developing a gas turbine auxiliary generator for range extender EV by applying turbocharger technology. The environmental impact of EV is small, and it is anticipated that the popularization will advance in each country in the future. However, there are still many problems such as the high battery cost and long charging time. Therefore, by mounting a small generator with an internal combustion engine in an EV, it is considered that the driving range can be extended and the charging timing of the battery can be improved. A motor generator is installed coaxially with a micro gas turbine developed based on a turbocharger. The turbine is driven by combustion gas from the combustor, compressed air is supplied to the combustor by a coaxial compressor, and surplus turbine output is recovered as electric power. Compared with a generator using a reciprocating engine, a gas turbine is compact, provides high output and cleaner exhaust gas, so that it may be able to satisfy the exhaust gas regulations without a post-processing device. Furthermore, the gas turbine has an advantage in that it can deal with various fuels simply by changing the combustor. Since gas turbines and turbochargers have many parts with common functions, it is possible to apply the turbocharger technology to the cost reduction of the system. Compact and highly-efficient generators are considered to be an effective technology not only for EV, but also for the range extension of other mobility platforms such as commercial vehicles, aircraft, and ships, which are expected to be electrified in the future.

### 5.3 Electric compressor for FCV

Electric compressor for FCV can control the boost pressure at fast response for the output demand of the fuel cell stack. In addition, miniaturization, higher efficiency, and noise reduction are also important elements, and MHIET has been developing an electric compressor for FCV applying the turbocharger and electric supercharger technology. In addition, by adopting a centrifugal compressor with one shaft and two stages, high boost pressure and long life of the bearing are possible, while also lowering the motor rotational speed.

## 6. Conclusion

This paper introduces the electric supercharging-related technologies that MHIET is developing for powertrain electrification. Among these technologies, the possibility of power performance improvement and fuel consumption reduction in the electric supercharger for 48V MHEV was confirmed through experiments and simulation. In the future, MHIET would like to contribute to the realization of a sustainable society by providing a turbocharging system corresponding to various powertrain technologies.

\*1 ECU: Electronic Control Unit. An electronic controller for engines.

\*2 CAN: Controller Area Network. A communication standard between electronic devices. It is used for communication between electronic devices used in automobiles.

\*3 Miller cycle: A technology that shortens the compression stroke of the engine by controlling the intake valve of the engine and substantially increases the expansion stroke. The application of Miller cycle improves the thermal efficiency of the engine and reduces the fuel consumption. However, engine torque decreases because the inflow of fresh air decreases.

\*4 EGR: Exhaust Gas Recirculation. To recirculate part of the exhaust gas of an engine to the intake side. In gasoline engines, by applying EGR, fuel consumption is reduced through the reduction of pressure

loss in the throttle valve, improvement in margin to knocking, and improvement in terms of heat loss. However, engine torque decreases because the ratio of fresh air to total air volume decreases.

- \*5 Turbocharging Downsizing: To achieve the same output as a large engine with a small engine with a turbocharger. Through this, the engine mechanical loss is reduced, and it is effective for fuel consumption improvement.
- \*6 SOC: State Of Charge. The amount of charge on the battery.
- \*7 Pumping loss: Loss caused when the piston pushes out the exhaust gas in the exhaust process due to pressure loss in the exhaust path.

## References

- (1) Yukio Yamashita, et al., Development of High-speed Single-phase Motor for Automotive Turbocharger, Mitsubishi Heavy Industries Technical Review Vol. 56 No. 1 (2019)
- (2) Byeongil An et al., Development of Two-stage Electric Turbocharging System for Automobiles, Mitsubishi Heavy Industries Technical Review Vol. 52 No. 1 (2015) p. 76 to 81
- (3) Yukio Yamashita, et al., Development of Electric Supercharger to Facilitate the Downsizing of Automobile Engines, Mitsubishi Heavy Industries Technical Review Vol. 47 No. 4 (2010) p. 17 to 12
- (4) Y. Yamashita et al., Two-stage boosting system using 48 volt electric compressor, 22nd Supercharging Conference 2017